

Surface Mount Circulators

Part Number: KTSC102M1-4

Key Features

- Vibration Resistance, Shock Resistance
- Compact Structure, Small Size
- High Frequency Characteristic
- High Production Efficiency
- Operating Temperature Range: -40°C~+85°C
- Widely Used in All Kinds of Base Stations, Small Power Amplifier etc.

Electrical Specifications at Room (25°C±5°C) Temperature

Part Number	Freq. Range (GHz)	Bandwidth Max. (MHz)	Insertion Loss Max. (dB)	Isolation Min. (dB)	VSWR Max.	Forward Power (W)	Connector Type
KTSC102M1-4	0.5 - 1.0	40	0.5	23	1.20	100	SMD

Mechanical Dimensions (mm)

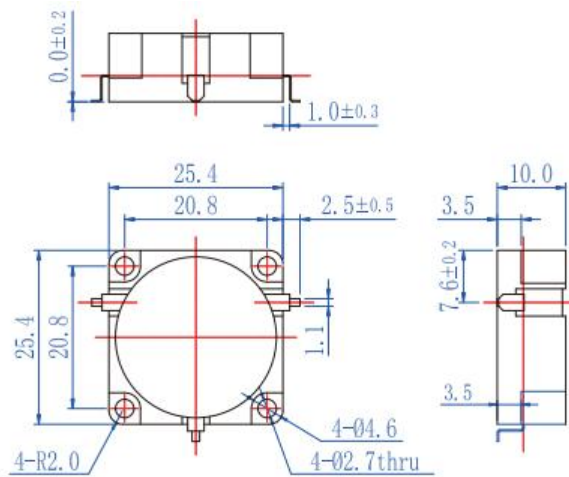

HOW TO ORDER

